

## 665-36WHT TOPAZ™ Fiberglass Bathtub Wall



Mustee model 665-36WHT shown with bathtub model T6036R



Mustee 665-36WHT TOPAZ™ provides quality and great design for your bathroom, complimenting Mustee's fiberglass TOPAZ™ bathtubs. Mustee 665-36WHT bathtub walls are the perfect touch.

### Features

- Produced from reinforced, molded fiberglass for a durable finish.
- Fits TOPAZ™ 36" x 60" Bathtub.
- Caulkless three panel wall system with tongue-and-groove seams.
- Mounts direct-to-stud with mounting flanges hidden behind drywall.
- Includes four molded-in, self-draining shelves.
- Smooth, white colorfast semi-gloss finish.
- Mold and mildew-resistant...easy to clean.
- Can accommodate grab bars per ADA.

### Code Accepted

TOPAZ™ and bathtub walls meet or exceed performance requirements:

- American Society of Testing and Materials (ASTM) E-84 
- American National Standards Institute (ANSI) Specification Z 124-2022 
- CAN/ULC S102-07 Burn and Smoke Test

### Design Features

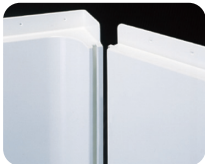

- Panels with tongue-and-groove seams.



- Reverse side of center panel has clips for securing to bathtub.



- 1 ¼" flanges fasten direct-to-studwalls with screws, drywall conceals flanges.



Includes four self-draining molded shelves.

### Specifications

Model	Description	Color	Fits Bathtub
665-36WHT	Bathtub Wall	White	T6036L/ T6036L-AFD
665-36WHT	Bathtub Wall	White	T6036R/ T6036R-AFD

**General:** Furnish and install as shown on plans, E.L. Mustee & Sons, Inc. 665-36WHT TOPAZ™ bathtub walls semi-gloss, three-piece wall system. Construction shall be molded, reinforced fiberglass using matched metal models with a uniform thickness. Shall meet ANSI Specification Z 124-2022. Color: White.

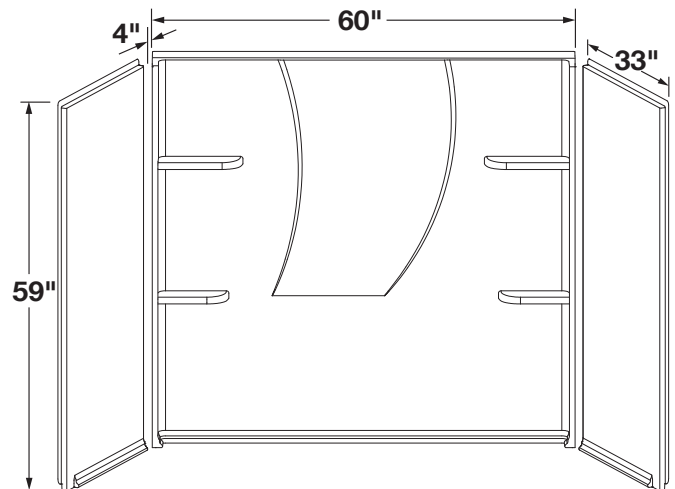

# T6036R/L TOPAZ™ Fiberglass Bathtubs 36" x 60"

## T6036R/L-AFD TOPAZ™ Above Floor Fiberglass Bathtubs 36" x 60"

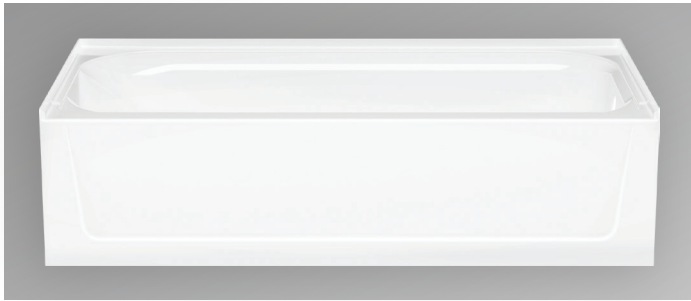

Model T6036R

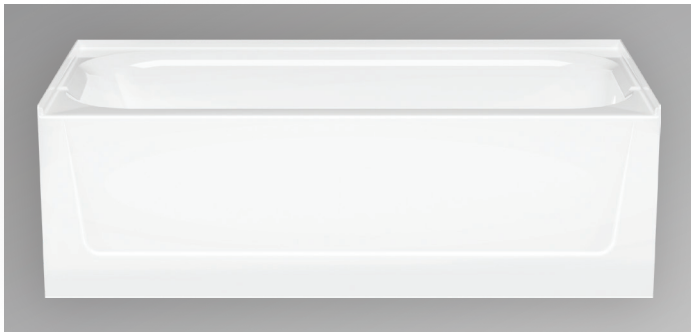

Model T6036R-AFD



TOPAZ™ premium fiberglass bathtubs bring together classic design, exceptional features, premium construction and legendary E.L. Mustee & Sons quality. These popular 36" x 60" bathtubs feature the latest thinking in bathtub design.

### Features

- Precision molded from Mustee's premium fiberglass.
- Apron supported by 2 molded brackets.
- Contoured back with a 20° lumbar slope for comfort.
- Finish creates a deep, long lasting shine.
- Slip-resistant bottom.
- One piece molded, with matched metal molds.
- Fits standard 36" x 60" alcove.
- Available right hand & left hand with an 8 ½" x 15" drain offset.
- Suitable for use with all popular finished wall treatments.
- Mold & mildew resistant – easy to clean.
- AFD model bottom is raised 3 ½" by molded supports.

### Code Accepted

TOPAZ™ bathtubs meet or exceed performance requirements:

- American Society of Testing and Materials (ASTM) E-84 
- American National Standards Institute (ANSI) Specification Z 124-2022 
- Inhalation Toxicity Test – to evaluate inhalation health hazard with combustible products
- CAN/ULC S102-07 Burn and Smoke Test

### Specifications

Model	Color	Style	Description
T6036L	White	Standard	36" x 60" Bathtub, Left hand drain
T6036R	White	Standard	36" x 60" Bathtub, Right hand drain
T6036L-AFD	White	Above Floor	36" x 60" Bathtub, Left hand drain
T6036R-AFD	White	Above Floor	36" x 60" Bathtub, Right hand drain

**General:** E.L. Mustee & Sons, Inc. TOPAZ™ Fiberglass Bathtub 36" x 60" right or left-handed Model \_\_\_\_\_. Construction shall be molded, reinforced fiberglass using matched metal molds. Shall meet ANSI Specification Z 124-2022. Color: White.

### T6036

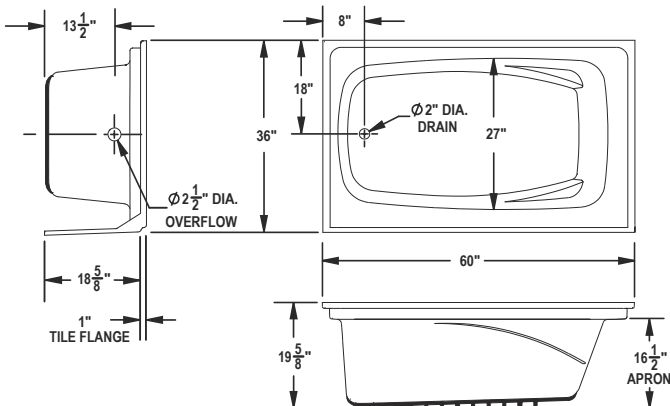

### T6036-AFD

